

**ELKAY**

**Circuit Chef™**



CS45WPK

## Price Guide

Prices effective July 2020

CS60CWK

\$4,875.00

Elkay Circuit Chef Stainless Steel 59-1/2" x 20-1/2" x 10", Single Bowl Undermount Sink Kit with Cherry Wood Boards

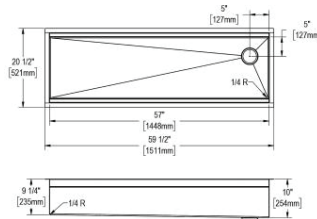

Includes: CS60LC Large Colander, CS60BG Bottom Grid, CS60CW Cherry Wood Cutting Boards, CSLPC Low Profile Colander  
Built in USA  
Extended Lead Time

Ship dims: 61-5/16" x 22-3/16" x 14-5/8"  
Approx. ship weight: 95 lbs.

- Dimensions: 59-1/2" x 20-1/2" x 10"
- 16 gauge
- Lustrous Satin finish
- 3-5/8" (92mm) drain opening
- Sound deadening: Full spray sides and bottom
- 63" minimum cabinet size

CS60BPK

\$4,875.00

Elkay Circuit Chef Stainless Steel 59-1/2" x 20-1/2" x 10", Single Bowl Undermount Sink Kit with Black Polymer Boards

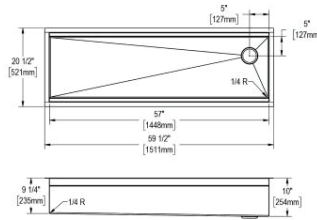

Includes: CS60LC Large Colander, CS60BG Bottom Grid, CS60BP Black Poly Cutting Boards, CSLPC Low Profile Colander  
Built in USA  
Extended Lead Time

Ship dims: 61-5/16" x 22-3/16" x 14-5/8"  
Approx. ship weight: 95 lbs.

- Dimensions: 59-1/2" x 20-1/2" x 10"
- 16 gauge
- Lustrous Satin finish
- 3-5/8" (92mm) drain opening
- Sound deadening: Full spray sides and bottom
- 63" minimum cabinet size

CS60WPK

\$4,875.00

Elkay Circuit Chef Stainless Steel 59-1/2" x 20-1/2" x 10", Single Bowl Undermount Sink Kit with White Polymer Boards

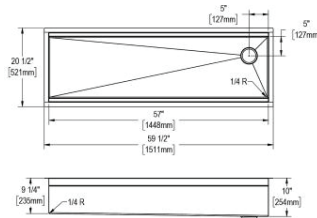

Includes: CS60LC Large Colander, CS60BG Bottom Grid, CS60WP White Poly Cutting Boards, CSLPC Low Profile Colander  
Built in USA  
Extended Lead Time

Ship dims: 61-5/16" x 22-3/16" x 14-5/8"  
Approx. ship weight: 95 lbs.

- Dimensions: 59-1/2" x 20-1/2" x 10"
- 16 gauge
- Lustrous Satin finish
- 3-5/8" (92mm) drain opening
- Sound deadening: Full spray sides and bottom
- 63" minimum cabinet size

CS45CWK

\$3,900.00

Elkay Circuit Chef Stainless Steel 45-1/2" x 20-1/2" x 10", Single Bowl Undermount Sink Kit with Cherry Wood Boards

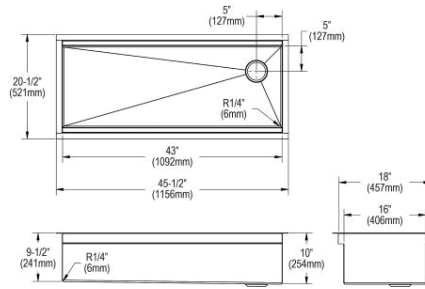

- Dimensions: 45-1/2" x 20-1/2" x 10"
- 16 gauge
- Lustrous Satin finish
- 3-5/8" (92mm) drain opening
- Sound deadening: Full spray sides and bottom
- 51" minimum cabinet size

Includes: CS3045SC Small Colander, CS45BG Bottom Grid, CS45CW Cherry Wood Cutting Boards, CSLPC Low Profile Colander  
Built in USA  
Extended Lead Time

Ship dims: 47-3/16" x 22-3/16" x 14-1/4"  
Approx. ship weight: 76 lbs.

CS45BPK

\$3,900.00

Elkay Circuit Chef Stainless Steel 45-1/2" x 20-1/2" x 10", Single Bowl Undermount Sink Kit with Black Polymer Boards

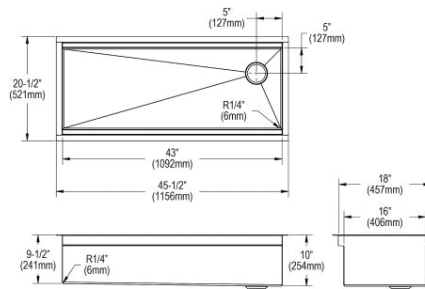

- Dimensions: 45-1/2" x 20-1/2" x 10"
- 16 gauge
- Lustrous Satin finish
- 3-5/8" (92mm) drain opening
- Sound deadening: Full spray sides and bottom
- 51" minimum cabinet size

Includes: CS3045SC Small Colander, CS45BG Bottom Grid, CS45BP Black Poly Cutting Boards, CSLPC Low Profile Colander  
Built in USA  
Extended Lead Time

Ship dims: 47-3/16" x 22-3/16" x 14-1/4"  
Approx. ship weight: 76 lbs.

CS45WPK

\$3,900.00

Elkay Circuit Chef Stainless Steel 45-1/2" x 20-1/2" x 10", Single Bowl Undermount Sink Kit with White Polymer Boards

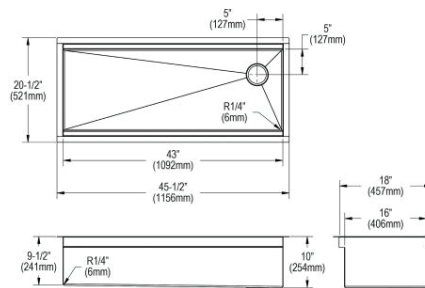

- Dimensions: 45-1/2" x 20-1/2" x 10"
- 16 gauge
- Lustrous Satin finish
- 3-5/8" (92mm) drain opening
- Sound deadening: Full spray sides and bottom
- 51" minimum cabinet size

Includes: CS3045SC Small Colander, CS45BG Bottom Grid, CS45WP White Poly Cutting Boards, CSLPC Low Profile Colander  
Built in USA  
Extended Lead Time

Ship dims: 47-3/16" x 22-3/16" x 14-1/4"  
Approx. ship weight: 76 lbs.

CS30CWK

\$2,450.00

Elkay Circuit Chef Stainless Steel 32-1/2" x 20-1/2" x 10", Single Bowl Undermount Sink Kit with Cherry Wood Boards



- Dimensions: 32-1/2" x 20-1/2" x 10"
- 16 gauge
- Lustrous Satin finish
- 3-5/8" (92mm) drain opening
- Sound deadening: Full spray sides and bottom
- 36" minimum cabinet size

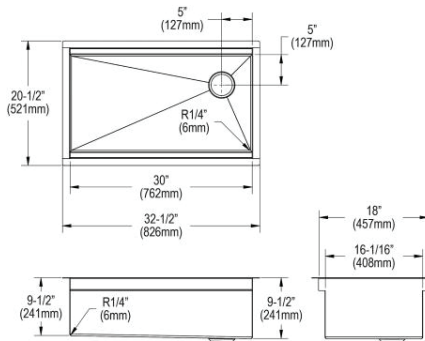

Includes: CS3045SC Small Colander, CS30BG Bottom Grid, CS30CW Cherry Wood Cutting Boards, CSLPC Low Profile Colander  
Built in USA  
Extended Lead Time

Ship dims: 34-5/16" x 22-3/16" x 15-1/2"  
Approx. ship weight: 60 lbs.

CS30BPK

\$2,450.00

Elkay Circuit Chef Stainless Steel 32-1/2" x 20-1/2" x 10", Single Bowl Undermount Sink Kit with Black Polymer Boards



- Dimensions: 32-1/2" x 20-1/2" x 10"
- 16 gauge
- Lustrous Satin finish
- 3-5/8" (92mm) drain opening
- Sound deadening: Full spray sides and bottom
- 36" minimum cabinet size

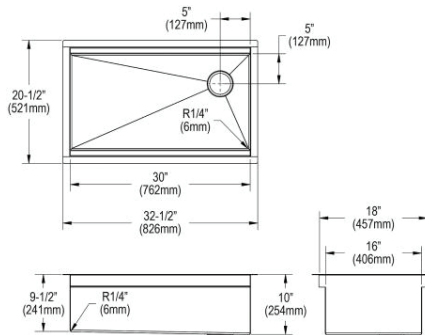

Includes: CS3045SC Small Colander, CS30BG Bottom Grid, CS30BP Black Poly Cutting Boards, CSLPC Low Profile Colander  
Built in USA  
Extended Lead Time

Ship dims: 34-5/16" x 22-3/16" x 15-1/2"  
Approx. ship weight: 60 lbs.

CS30WPK

\$2,450.00

Elkay Circuit Chef Stainless Steel 32-1/2" x 20-1/2" x 10", Single Bowl Undermount Sink Kit with White Polymer Boards





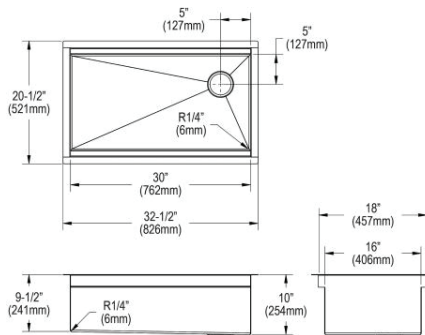













- Dimensions: 32-1/2" x 20-1/2" x 10"
- 16 gauge
- Lustrous Satin finish
- 3-5/8" (92mm) drain opening
- Sound deadening: Full spray sides and bottom
- 36" minimum cabinet size









Includes: CS3045SC Small Colander, CS30BG Bottom Grid, CS30WP White Poly Cutting Boards, CSLPC Low Profile Colander  
Built in USA  
Extended Lead Time

Ship dims: 34-5/16" x 22-3/16" x 15-1/2"  
Approx. ship weight: 60 lbs.

<b>Bottom Grids</b>			
<b>Model</b>	<b>List Price</b>	<b>Description</b>	<b>Image</b>
CS30BG	\$210.00	Elkay Circuit Chef Stainless Steel 29-1/2" x 15-3/8" x 1-1/4" Bottom Grid	
CS45BG	\$315.00	Elkay Circuit Chef Stainless Steel 42-7/16" x 15-3/8" x 1-1/4" Bottom Grid	
CS60BG	\$420.00	Elkay Circuit Chef Stainless Steel 56-9/16" x 15-3/8" x 1-1/4" Bottom Grid	

Cutting Boards			
Model	List Price	Description	Image
CS30BP  	\$242.00	Elkay Circuit Chef Black Polymer 30-3/4" x 18-3/4" x 3/4" Cutting Boards	
CS30CW	\$242.00	Elkay Circuit Chef Cherry Wood 30-3/4" x 18-3/4" x 3/4" Cutting Boards	
CS30WP  	\$242.00	Elkay Circuit Chef White Polymer 30-3/4" x 18-3/4" x 3/4" Cutting Boards	
CS45BP	\$346.00	Elkay Circuit Chef Black Polymer 43-3/4" x 18-3/4" x 3/4" Cutting Boards	
CS45CW	\$346.00	Elkay Circuit Chef Cherry Wood 43-3/4" x 18-3/4" x 3/4" Cutting Boards	
CS45WP	\$346.00	Elkay Circuit Chef White Polymer 43-3/4" x 18-3/4" x 3/4" Cutting Boards	
CS60BP	\$457.00	Elkay Circuit Chef Black Polymer 57-3/4" x 18-3/4" x 3/4" Cutting Boards	
CS60CW	\$457.00	Elkay Circuit Chef Cherry Wood 57-3/4" x 18-3/4" x 3/4" Cutting Boards	
CS60WP	\$457.00	Elkay Circuit Chef White Polymer 57-3/4" x 18-3/4" x 3/4" Cutting Boards	

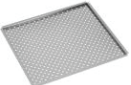
<b>Colanders</b>			
<b>Model</b>	<b>List Price</b>	<b>Description</b>	<b>Image</b>
CS3045SC  	\$300.00	Elkay Circuit Chef Stainless Steel 17" x 6-5/8" x 4" Colander	
CS60LC	\$300.00	Elkay Circuit Chef Stainless Steel 17" x 9-5/8" x 4" Colander	
CSLPC  	\$300.00	Elkay Circuit Chef Stainless Steel 18-3/4" x 17-1/8" x 1/2" Low Profile Colander	



CS45

## ABOUT ELKAY

For more than 100 years, Elkay® Manufacturing has been making innovative products and providing exceptional customer care. Like your family, Elkay has values and traditions that endure. We take pride in offering reliable products that inspire change and leave the world a better place for generations to come.

Headquartered in Downers Grove, Illinois, Elkay is American owned and operated, providing thousands of jobs that support our families and communities. We are proud to be America's No. 1 selling kitchen sink company, as well as a leading manufacturer of award-winning water delivery products, including the ezH2O® bottle filling station.

**ELKAY**

1333 Butterfield Road, Suite 200 Downers Grove, IL 60515 | 630.574.8484  
elkay.com | ©2020 Elkay Manufacturing Company

(7/20) F-5399-ELK