

TO BE REMOVED FOR USE BY THE OCCUPANT!



Installation Instructions

Quartz Sink

- READ THESE INSTRUCTIONS THOROUGHLY BEFORE YOU BEGIN.
- Follow all local plumbing and building codes.
- Before installation, please inspect the sink for damage. Do not install a damaged sink.
- For undermount sinks proceed to section I. For drop-in sinks proceed to section II.

I. UNDERMOUNT INSTALLATION

ATTENTION INSTALLER:

- ELKAY RECOMMENDS THAT UNDERMOUNT SINKS SHOULD BE INSTALLED BY A PROFESSIONAL EXPERIENCED INSTALLER.
- **WARNING: THE CUTOUT TEMPLATE PROVIDES A SINK OPENING THAT WILL EXPOSE THE SINK RIM LEDGE AS SHOWN ON THE TEMPLATE. (SEE ILLUSTRATION A)**
- IT IS RECOMMENDED THAT YOU DISCUSS THIS WITH YOUR CUSTOMER AND AGREE TO WHAT THE FINISHED EFFECT WILL BE. ELKAY IS NOT RESPONSIBLE FOR IMPROPER SINK OR COUNTERTOP INSTALLATIONS.
- ELKAY QUARTZ UNDERMOUNT SINKS MUST BE FASTENED TO SOLID SURFACE COUNTERTOPS ONLY (I.E. GRANITE).
- ELKAY IS NOT RESPONSIBLE FOR SINK AND COUNTERTOP IF DAMAGED DURING INSTALLATION.
- FOLLOW ALL LOCAL PLUMBING AND BUILDING CODES.

1. Position template on countertop. Locate front to rear, so sink will not interfere with the cabinet.
2. Trace a line around the template. Cut along the inside of this line to provide opening.
3. Locate and provide for the mounting holes (following the countertop manufacturer's instructions). Holes should allow for even spacing around sink. Type of fasteners to be as recommended by countertop supplier.
4. Fasten mounting brackets to countertop loosely
5. Using a high quality silicone adhesive caulk, apply a bead evenly all around the top of the sink flanges. **CAUTION: DO NOT USE EPOXY TO SEAL SINK.**
6. Position and align the sink in the countertop opening.
7. Tighten fasteners until mounting brackets are snug against sink. (See illustration A).
8. Check alignment of sink to countertop opening.
9. Tighten down fasteners evenly. **Be careful not to over-tighten.** Remove excess caulk and allow caulk to cure following the caulk manufacturer's instructions.

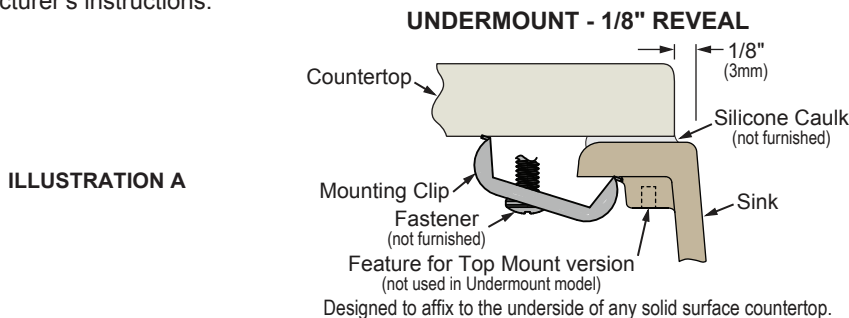

II. DROP-IN INSTALLATION

Note: The clips provided are designed for a maximum countertop thickness of 1-3/4".

1. To determine the proper size opening for your sink place the sink upside down on top of the countertop. Mark or trace line around the edge of the rim. Then cut an opening 5/16" inside the line. (See illustration B).

2. Set new sink in opening to see that it fits properly.

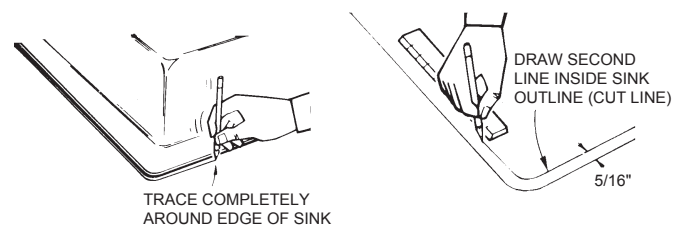

II. DROP-IN INSTALLATION Cont.

Note: MUST SUPPORT FAUCET DECK ON BOTH SIDES WHILE PUNCHING FAUCET HOLES.

3. Faucet Holes: Faucet holes can be identified by the faucet hole emboss on the underside of the faucet deck and the corresponding circular labels located on the faucet deck top surface. Before punching the holes please verify that the circular labels are properly centered over the faucet emboss. The faucet hole should be carefully penetrated **FROM ABOVE THE SINK** using chisel or screw driver and tapping lightly on the circular labels. (See illustration C). If necessary the hole can be enlarged using a metal hole saw, a jigsaw with a metal cutting blade or a metal file.

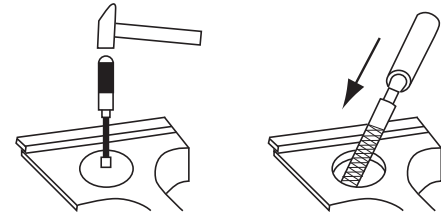

ILLUSTRATION C

4. Attach faucet, drain fittings and accessories according to the manufacturer's instructions.

5. Determine if your sink was shipped with the **ORANGE DOWEL CLIP** or the **BLACK / GRAY SLOTTED SCREW CLIP**. If **ORANGE DOWEL CLIP**, go to step 7. If **BLACK / GRAY SLOTTED SCREW CLIP**, proceed to step 6.

6. As shown in illustration D and E, align clips with the corresponding slots in the sinks per illustration D. It may be necessary to use a mallet and wood block to push it into place, as shown in illustration E. Make sure metal portion of the clip (clamp) is in the open position so that sink can be dropped into cutout. Proceed to step 8.

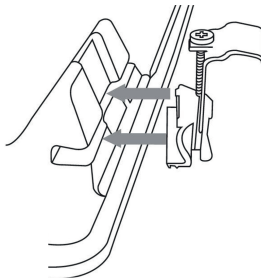

ILLUSTRATION D

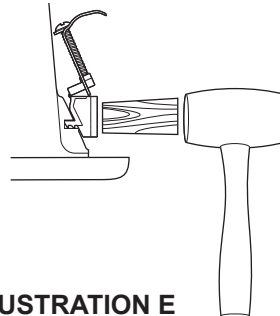

ILLUSTRATION E

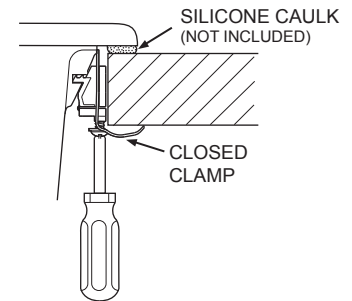

ILLUSTRATION F

7. As shown in illustration G and H, align clips with the corresponding holes in the sink and gently push into place. Push plastic pins on the clips inward completely so that the clip expands and engages the sink. Note that it may be necessary to use a pin punch or screw driver and hammer to push pin in completely. Make sure metal portion of the clip (clamp) is in the open position so that the sink can be dropped into cutout.

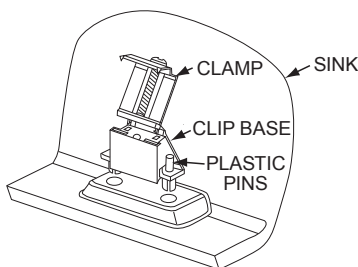

ILLUSTRATION G

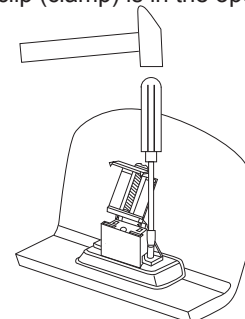

ILLUSTRATION H

8. Apply a bead of a high quality silicone adhesive caulk to the underside of the sink rim and position sink into countertop opening. **CAUTION: DO NOT USE EPOXY TO SEAL SINK.**

9. Swing metal portion of clip (clamp) into the clip base. (See illustration F). Using a Phillips screw driver, turn screw until clamp engages the countertop. Use shims if necessary.

10. Remove excess caulk and allow caulk to cure following the caulk manufacturer's instructions.



Installation Instructions

CARE AND CLEANING GUIDE

Elkay Quartz sinks were created for a lifetime of easy care. Just follow the simple guidelines listed below.

Routine Care

Most dirt and stains: Wipe with a damp cotton cloth/sponge and soapy water. Towel dry with a cotton cloth. *It is recommended that you clean your sink prior to first use.*

Stubborn stains and water marks: Wipe with a Mr. Clean® Magic Eraser® and either water or a 50/50 white vinegar and water solution. Towel dry with a cotton cloth.

Difficult stains: Use a 3M Scotch-Brite™ Heavy Duty Scour Pad with either water, 50/50 white vinegar and water solution or non-abrasive cleaner. Start cleaning in a circular motion with a constant pressure over the area of the stain, rinse thoroughly with water and dry with a cotton cloth. Let dry 5-10 minutes. If stain persists, repeat.

MR CLEAN and MAGIC ERASER are trademarks of The Procter & Gamble Company. 3M and SCOTCH-BRITE are trademarks of 3M Company.

Preventing Damage

•Avoid exposing Elkay Quartz sinks to strong chemicals, such as paint removers, oven cleaners, etc. If contact occurs, quickly flush the surface with water. Do not use straight or undiluted bleach solution.

•Do not use any abrasive cleaning products, scouring pads or steel wool.

•Do not use caustic solutions containing ammonia or alkalis. Examples include certain bath and drain cleaner products.

ELKAY LIMITED LIFETIME QUARTZ SINK WARRANTY

Elkay warrants to the original purchaser of an Elkay Quartz sink that Elkay will, at its option, replace or repair, without charge, such product if it fails due to a manufacturing defect for a lifetime of normal residential use. Product replacement does not include transportation cost or labor installation cost. This warranty covers only Quartz drop-in sinks installed in a conventional countertop surface and Quartz undermount sinks installed in a conventional solid surface countertop and applies to residential installations only. Elkay reserves the right to examine product in question and its installation prior to replacement.

WASTE FITTINGS AND ACCESSORIES ARE NOT WARRANTED OTHER WARRANTY CONDITIONS ON SINKS

This warranty applied to sinks purchased after August 1st 2007 as shown on the purchaser's dated receipt. Our warranty does not cover product failure or damage caused by abusive treatment, misuse, environmental factors, normal wear including dents and scratches, improper care and cleaning, use of aggressive and abrasive cleaners, damage due to handling or failure to follow the recommended procedures for installation, care and maintenance as detailed in the installation and care guide provided with every sink. This warranty is extended only to the original consumer purchaser of the product. This warranty does not cover shipping costs, labor costs, or any other charges for such items as installation or replacement of the sink, diagnosis or replacement of any faucet or component part, or any other expense or loss.

All incidental or consequential damages are specifically excluded. No additional warranties, express or implied are given, including but not limited to, any implied warranty of merchantability or fitness for a particular purpose.

Some states do not allow the exclusion or limitation of incidental or consequential damages or limitations on how long an implied warranty lasts, so the above limitations or exclusions may not apply to you. This warranty gives you specific legal rights, and you may also have other rights which vary from state to state.

TO OBTAIN SERVICE UNDER WARRANTY

1. Write to: Elkay Manufacturing Company
Attention: Consumer Services
2222 Camden Court
Oak Brook, IL 60523
2. Include a letter containing the following information:
 - a.Date of purchase and installation
 - b.Proof of Purchase (copy of original dated invoice)
 - c.Description of nature of defect
 - d.Model number or description of model and/or component part if possible.